



Power Controller

Single Phase Power Controller

THV-10 Series



• CE marking : A specified noise filter must be used.



Single Phase Power Controller

THV-10  
 (20A, 30A, 45A, 60A, 80A, 100A)

Digital Communication Function

(Optional)



The THV-10 offers an optional RS-485 communications interface for networking to computers, PLCs and operation panel.

RS-485

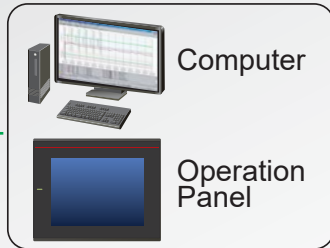

Analog Retransmission Output

(Optional)



An analog output is available so that the effective value can be retransmitted an analog signal to a remote instrument such as a recorder or data-logging equipment.

0 to 10V DC

Current Value, Power Value
(Effective value)



Recorder Digital Indicator

- Select either Digital Communication or Analog Retransmission Output.

Lightweight

THV-10
(20A, 30A type)



Approx. 0.45kg

Easy parameter setup via USB loader port

The THV-10 series has a standard loader port to connect to a PC USB port via COM-K () (USB communication converter).

Using PROTEM2 software on the PC, parameter settings can be easily saved on the PC in CSV format, and the same parameter settings are easily copied to other controllers.

- The Loader port is only for parameter setup

Easy Data Management
Communication Tool
Data monitoring, setting, storage, copy,
transfer, logging, and report creation

PROTEM2

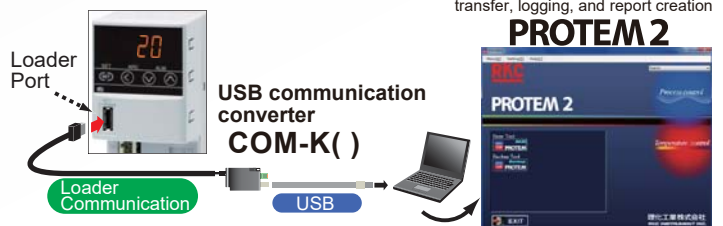

Simply download "PROTEM2" from the RKC Instrument web site (www.rkcinst.com).

Easy and accurate setting

Single phase power controller THV-10 has an LED display to show set values and input signals, and front keys for easy setting and monitoring. Setting can also be made with an external setting unit (variable resistor).

Three types of control modes are selectable

○ Phase control

The wave form of the load power is switched at a desired phase angle θ to provide smooth control.



○ Zero-cross control

Power is switched on and off when the supply voltage is at 0V. This system suppresses high frequency noise inherent to phase control.



○ Zero-cross control

(Input synchronization system)

Supply voltage is switched on and off according to the voltage pulse or contact signals from a controller.



PV or SV Display

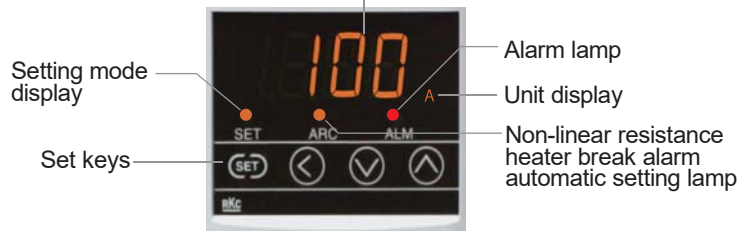

Detects heater break of non-linear load

(Optional)

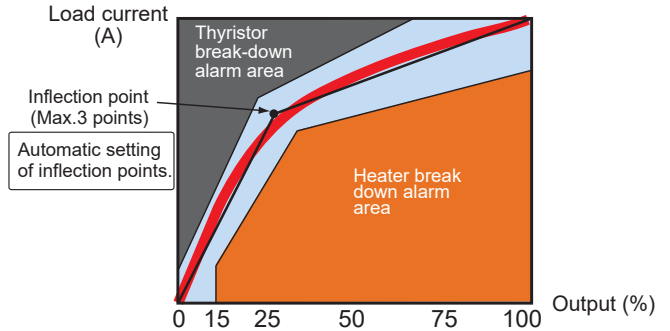

Standard Functions

Gradient setting

The relation between the setting input and the output voltage can be set. Gradient setting is possible via front keys or an external setter. Control characteristics may vary with the setting as follows.

Gradient setting output characteristic diagram

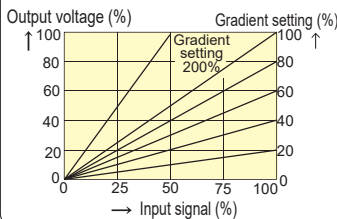

Ramp function (Soft-start & Soft-down)

Even if setting input changes abruptly, output changes slowly to suppress inrush current. Ramp-up (Start-up) and ramp down (Start-Down) time can be set in the range of 0.1 to 100.0 sec via front keys.

Soft-start & Soft-down action diagram

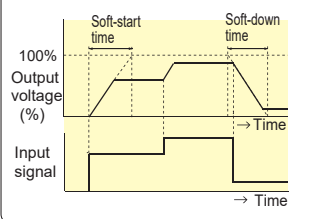

Base-up setting (Output bias)

Output bias can be set via front keys. (Base-up setting is valid when output limiter low is set to 0.0)

Base-up output characteristic diagram

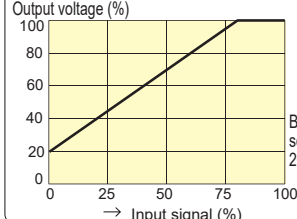

Output limiter (High & Low)

Output highest and lowest values can be set via front keys.

High & Low limiter characteristic diagram

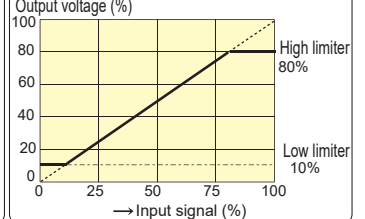

Output modes

When phase control is selected for linear load (R: resistor), output mode can be selected among Proportional phase angle to input, proportional voltage to input and proportional square voltage (electric power) to input.

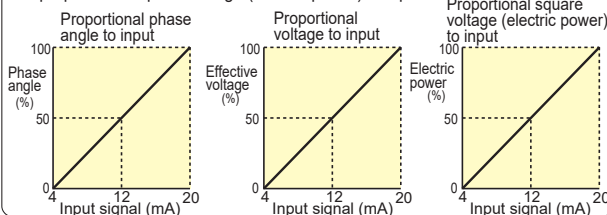

Output limiter High at start-up

This function limits the highest output for the period of a preset time after power-ON and control mode change from Stop to Run. It makes the THV-10 Series suitable for heaters which cause rush current flow, such as Halogen lamp, Tungsten, Platinum, and Molybdenum heaters.

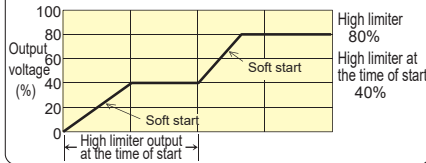

Event input

Functions can be assigned to one external contact inputs. Switching of functions can be made externally with contact signals.

Phase control/Zero-cross control (Continuous proportional)
RUN/STOP
Auto/Manual
External manual/Internal Manual
Heater break alarm : Use/Unuse
Soft-up/Soft/down : Use/Unuse
Setting data lock : Use/Unuse
Over current alarm : Use/Unuse

Optional Functions

Constant current control (For phase control only)

This function maintains the output current constant when a load or a power supply fluctuates. It makes the THV Series suitable for heaters of which resistance greatly changes by temperature change, such as Platinum, Molybdenum, Tungsten, and Kanthal heaters.

Constant current control characteristic diagram

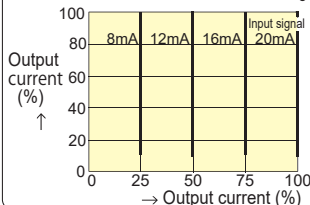

Power proportional control (For phase control only)

This function controls the output to make its effective value power proportional to the input. It makes the THV Series suitable for heaters of which resistance gradually increases by temperature or time, such as silicon carbide type heater.

Power proportional control characteristic diagram

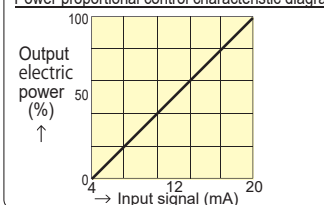

Load current limiter (For phase control only)

This function limits the load current value to the heater. The setting range is 30 to 100% of the rated current.

(Note)
If the load has a large inrush current, use soft-start function along with this function to suppress the inrush current. This function alone can not prevent the inrush current.

Current limiter characteristic diagram

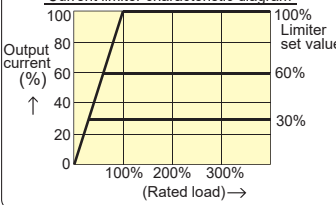

Heater break alarm

This function measures load current and compares it with a heater break alarm set value. Alarm will be activated if the load current goes into alarm ranges. Maximum two alarm set points can be set for the heater break alarm, which could be used for heater-deterioration alarm and heater-break alarm.

(Note)
For phase control, heater break alarm does not work when the load current is less than 15% of maximum load current.

Over-current alarm

The alarm goes on when the load current exceeds 120% of the rated current.

Alarm output

The alarm types are Power frequency abnormal, Thyristor break alarm, Heater break alarm and FAIL. Alarm output will go on, when any of them goes in alarm status. (Alarm output : 1 points, Energized/De-energized is selectable. FAIL is De-energized (Fixed).)

Protection function for control of primary side of a transformer

If momentary power failure occurs during execution of the control of primary side of a transformer, inrush current is generated. Protection function for control of primary side of a transformer is to protect the thyristor from the inrush current. To control the primary side of the transformer, it is recommended to purchase a THV-1 with a protection function for control of primary side of a transformer.

Specifications

Rated current	: 20A, 30A, 45A, 60A, 80A, 100A AC
Control method	: Phase control/ Zero-cross control (Selectable)
Applicable load	: Linearity (R:Resistor) load, Control of primary side of a transformer (The magnetic flux density must be 1.25T [12,500 Gauss] or less when the protection function for control of primary side of a transformer is not provided.) *1 Zero-cross control : Linearity (R:Resistor) load
Input signal	: Current input 4 to 20mA DC (Input impedance : 50Ω) Voltage input 1 to 5V DC (Input impedance : 30kΩ) Voltage input 0 to 10V DC (Input impedance : 30kΩ) Voltage pulse input 0/12V DC (Input impedance : 30kΩ)
Input sampling cycle	: 10ms at 50Hz, 8.33ms at 60Hz
Min. load current	: 20A : 0.6A (at 98% output of rated voltage) 30A,45A,60A,80A,100A : 1A (at 98% output of rated voltage)
Output voltage range	: 0 to 98% of rated voltage
Power OFF leakage current	: Approx. 27mA rms or less (Load voltage 200V rms, 60Hz, Ta=25°C)
Power supply voltage for Load	: 85 to 264V AC (Including power supply voltage variation) Rating : 100 to 240V AC
Power supply voltage for Control	: 85 to 264V AC (Including power supply voltage variation) Rating : 100 to 240V AC
Power frequency	: 50/60Hz (Automatic detection)
Allowable power frequency variation	: Power supply voltage for load 50±1Hz, 60±1Hz Power supply voltage for control 50±2Hz, 60±2Hz
Power consumption	: Less than 6VA (at 100V AC), Rush current 5.6A or less Less than 8VA (at 240V AC), Rush current 13.3A or less
Output setting range	: Gradient setting : 0.00 to 2.00 [Front key] 0 to 100% [External setting unit] Output limiter (High) : 0.0 to 100.0% [Front key] Output limiter (Low) : 0.0 to 100.0% [Front key] Output limiter at start-up (High) : 0.0 to 100.0% [Front key] Output limiter time at start-up : 0 to 600 sec [Front key] Base-up setting (Output bias) : -9.9 to 100.0% [Front key] Manual setting : 0.0 to 100% [Front key] 0 to 100% [External setting unit]
Output mode	: a) Proportional phase angle • Proportional voltage • Proportional square voltage b) Constant current control, Power proportional control • a) : Standard function, b) : Optional function
Cooling method	: Natural convection
Ambient temperature	: -15 to +55°C (Operation guarantee range)
Ambient humidity	: 5 to 95%RH (Non-condensing) Absolute humidity : MAX.W.C 29g/m ³ dry air at 101.3kPa
Dielectric voltage	: Between main circuit terminals, power terminals for control and heat sink 2500V AC for one minute. Between main circuit terminals, heat sink and input terminals 2500V AC for one minute. Between power terminals for control and input terminals 2300V AC for one minute.
Insulation resistance	: Between main circuit terminals, power terminals for control and heat sink 20MΩ or more (500V DC) Between main circuit terminals, heat sink and input terminals 20MΩ or more (500V DC) Between power terminals for control and input terminals 20MΩ or more (500V DC)
Self-diagnostic function	: a) Data check, Back-up check, A/D converter check, Watch dog-timer, Power supply voltage check b) Action at abnormality : Thyristor output OFF, FAIL output open
Mounting method	: Vertical mounting
Weight	: Approx. 0.45kg (20A, 30A) Approx. 1.2kg (45A, 60A) Approx. 1.8kg (80A, 100A)

Standard functions	<ul style="list-style-type: none"> • Auto/Manual selection (External manual setting unit is optional) • Gradient setting (External setting unit is optional) • Soft-up/Soft-down : 0.0 to 199.9sec • Contact input : 1 points, Non-voltage contact input (Phase control/Zero-cross control (Continuous proportional) RUN/STOP, Auto/Manual, Soft-up/Soft-down : Use/Unuse Setting data lock : Use/Unuse, Over current alarm : Use/Unuse (Selectable)) • ON/OFF control (External setting units are optional) • Loader communication : ANSI/RKC standard protocol Connection : RKC loader cable
Option function	<ul style="list-style-type: none"> • Alarm output : 1 point Open collector output, Sink type Maximum load current : 100mA, Load voltage : Less than 30V DC Energized/De-energized is selectable. (FAIL is de-energized only) (Heater break alarm, Thyristor break alarm, Power frequency abnormal, Over current alarm, FAIL) * Selectable • Heater break alarm Current measuring accuracy : ±5% of rated load current or ±2A (Whichever is larger) • Load current limiter Setting range : 20A, 30A : 0.0 to 32.0A, 45A : 0.0 to 55.0A 60A : 0.0 to 70A, 80A : 0 to 90A 100A : 0.0 to 110A • Analog Retransmission Output Continuous voltage output : 0 to 10V DC (Load resistance : More than 1kΩ) • Communication Function Communication method : RS-485 Protocol : ANSI X3.28(1976) 2.5 A4 MODBUS-RTU Communication speed : 2400, 4800, 9600, 19200, BPS Bit format : Start bit : 1 Data bit : 7 or 8 • For MODBUS 8 bit only Parity bit : Without, Odd or Even Stop bit : 1 or 2
Compliance with Standards	<ul style="list-style-type: none"> UL : UL508 [File No. E177758] cUL : C22.2 No.14 [File No. E177758] CE marking : LVD : EN60947-4-3 (Form 4) Rated insulation voltage : 690V EMC : EN60947-4-3 (Form 4) • A specified noise filter must be used SOSHIN ELECTRIC CO., LTD 20A : NF3020C-SVB, Leakage current : 1.5mA 30A : NF3030C-SVB, Leakage current : 1.5mA 45A : NF3050C-SVB, Leakage current : 1.2mA 60A : NF3060C-SVB, Leakage current : 1.2mA 80A : HF3080C-SZC, Leakage current : 1.2mA 100A : HF3100C-SZC, Leakage current : 1.2mA

*1 : If momentary power failure occurs during execution of the control of primary side of a transformer, inrush current is generated.
Protection function for control of primary side of a transformer is to protect the thyristor from the inrush current.

Table of internal calorific value

Rated load current (A)	20	30	45	60	80	100
Internal calorific value (W)	30	43	63	84	112	140

Table of Stability

Function	Operating condition	Stability
Constant current variation	Power supply variation : Within ±10% Load variation : 2 times	Within ±10% of rated current
Power control variation	Load variation : 2 times	Within ±10% of rated power (Load power voltage x max. rated current / 2)

• Temperature characteristics of load current

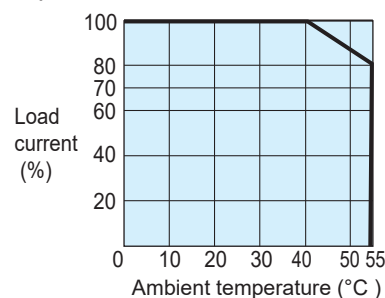

External Dimensions

Unit : mm

○ 20A, 30A type

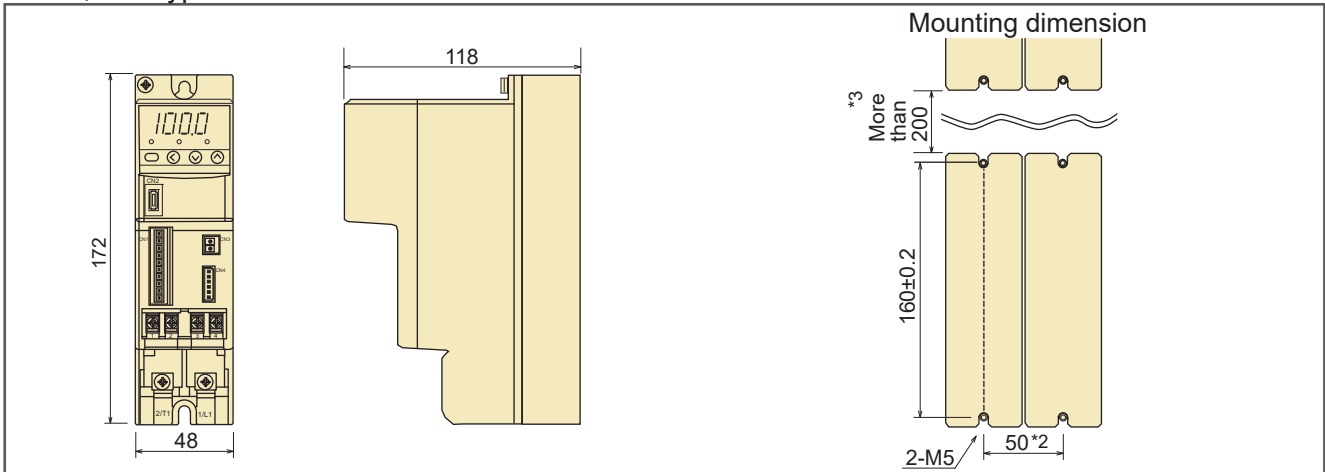

○ 45A, 60A type

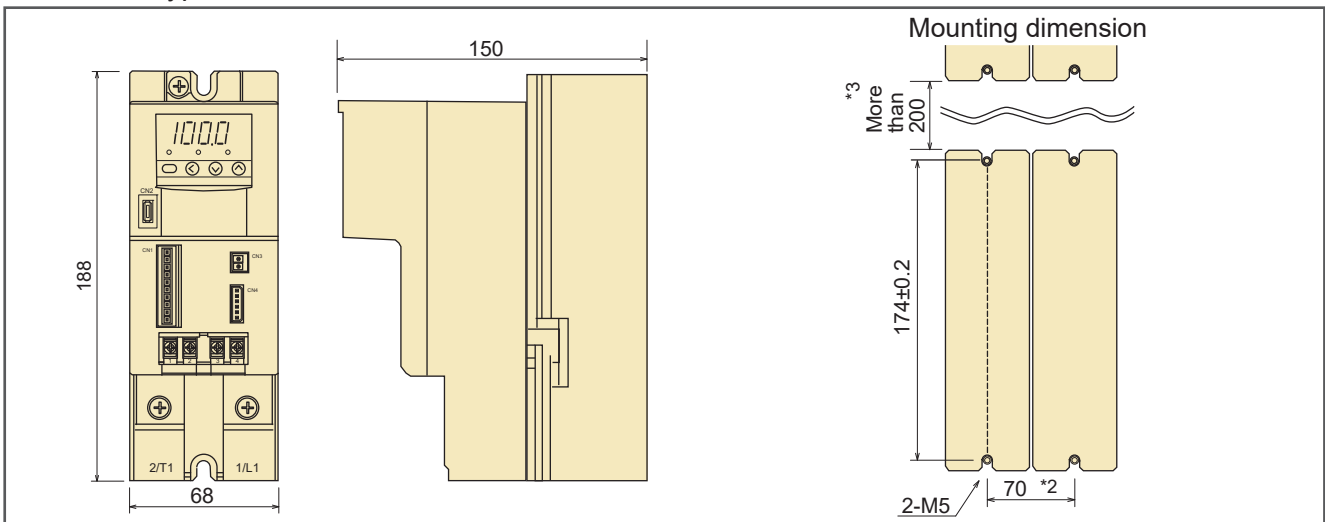

○ 80A, 100A type

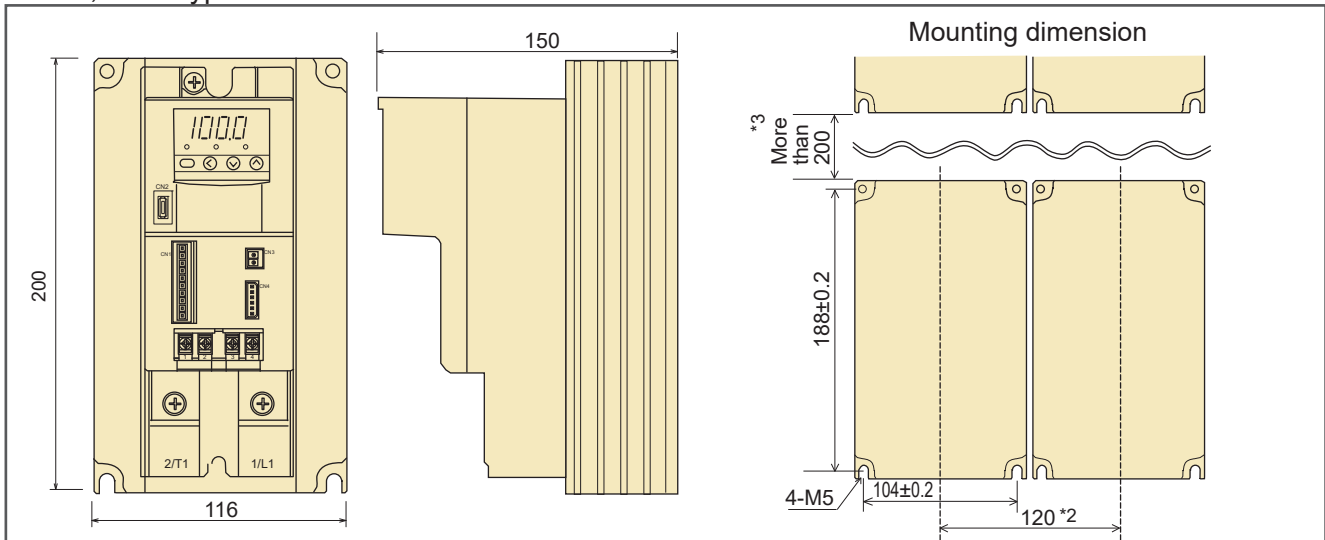

• Install the instrument as illustrated in the drawing to increase the cooling effect.

* Minimum space when mounted closely side by side.

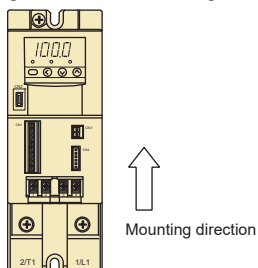

Model and Suffix Code

Specifications	Model and Suffix Code	
Type	Single phase 100 to 240 AC	THV-10 PZ <input type="checkbox"/> - <input type="checkbox"/> * <input type="checkbox"/> <input type="checkbox"/> <input type="checkbox"/> - <input type="checkbox"/>
Control method	Phase control/Zero-cross control (programmable, default: phase control)	PZ <input type="checkbox"/> <input type="checkbox"/> <input type="checkbox"/> <input type="checkbox"/> <input type="checkbox"/> <input type="checkbox"/>
Rated load current	20A AC 020
	30A AC 030
	45A AC 045
	60A AC 060
	80A AC 080
	100A AC 100
Input signal *1	0 to 10V DC 5
	1 to 5V DC 6
	4 to 20mA DC 8
	Voltage pulse input 0/12V DC V
<ul style="list-style-type: none"> • Heater break alarm • Current limiter • Constant current control • Power proportional control • Protection function for control of primary side of a transformer 	No function N
	Heater break alarm, Current limiter, Constant current control, Power proportional control, Protection function for control of primary side of a transformer H
	Non-linear resistance heater break alarm, Current limiter, Constant current control, Power proportional control, Protection function for control of primary side of a transformer B
Alarm output	No alarm output N
	Alarm output 1 point * Connector for Input/Output (Plug) is necessary. A
Analog retransmission output or communication function	No function N
	0 to 10V DC * With connector for analog retransmission output A
	RS-485 (ANSI/RKC standard protocol) * With connector for communication B
	RS-485 (MODBUS protocol) * With connector for communication C
The plug connector for Input/Output *2,*3	Not supplied N
	With the plug connector for Input/Output 1

*1 : Input signal is programmable. When contact input is required, specify the connector for input/output as an accessory.

*2 : Setters are for external gradient setting, external manual setting, and external high/low setting for on/off control.

Accessories

• Please refer to the following codes to order accessories.

• The rating of the fast-blow fuse may be different from the current rating of the THV-10 main unit.

Name	Code	Note
Setter	THV1P-S01	
Connector for Input/Output (Plug)	For input/output	THV1P-C01
	For analog retransmission	THV1P-C02
	For communication	THV1P-C03
Fuse unit (Fast-blow fuse [1 piece] + Holder [1 circuit type])	20A	THVP-F22
	30A	THVP-F32
	45A	THVP-F42
	60A	THVP-F62
	80A	THVP-FA2
	100A	THVP-FA2
Fast-blow fuse [1 piece] (For 1 circuit type) *1	20A	THVP-F2A CR6L-20/UL
	30A	THVP-F3A CR6L-30/UL
	45A	THVP-F45 CR6L-50/UL
	60A	THVP-F60 CR6L-75/UL
	80A	THVP-FA0 CR6L-100/UL
	100A	THVP-FA0 CR6L-100/UL
Fuse holder [1 circuit type]	20A	THVP-H02
	30A	THVP-H02
	45A	THVP-H02
	60A	THVP-H02
	80A	THVP-H03
	100A	THVP-H03
Fuse unit (Fast-blow fuse [1 piece] + Holder [3 circuit type])	20A	THVP-F21
	30A	THVP-F31
Fast-blow fuse [1 piece] (For 3 circuit type)	20A	THVP-F20 CR2LS-20
	30A	THVP-F30 CR2LS-30
Fuse holder [3 circuit type]	20A	THVP-H01
	30A	THVP-H01

Name	Code	Note
UL/CE Marking type Fast-blow fuse unit (Fast-blow fuse [1 piece] + Holder [1 circuit type])	20A	THVP-F23
	30A	THVP-F33
	45A	THVP-F43
	60A	THVP-F63
	80A	THVP-F83
	100A	THVP-FA3
UL/CE Marking type Fast-blow fuse [1 piece] *2	20A	THVP-F2B 5017906(20A)
	30A	THVP-F3B 5017906(30A)
	45A	THVP-F4B 5014006(50A)
	60A	THVP-F6B 5014006(63A)
	80A	THVP-F8B 5014006(80A)
	100A	THVP-FAB 5014006(100A)
UL/CE Marking type Fuse holder [1 circuit type]	20A	THVP-H04
	30A	THVP-H04
	45A	THVP-H05
	60A	THVP-H05
	80A	THVP-H05
	100A	THVP-H05
Output Voltmeter	Span : 150V AC	THVP-V01 • Manufactured by Daiichi Electronics Co., Ltd. : LSK-8CH 150V
	Span : 300V AC	THVP-V02 • Manufactured by Daiichi Electronics Co., Ltd. : LSK-8CH 300V

*1: Fast-blow fuse and Fuse holder : Manufactured by HINODE Electric Co. Ltd.

*2 : UL/CE Marking type Fast-blow fuse and Fuse holder : Manufactured by SIBA GmbH & Co.KG (Germany)

External Wiring

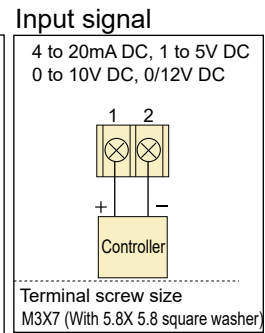
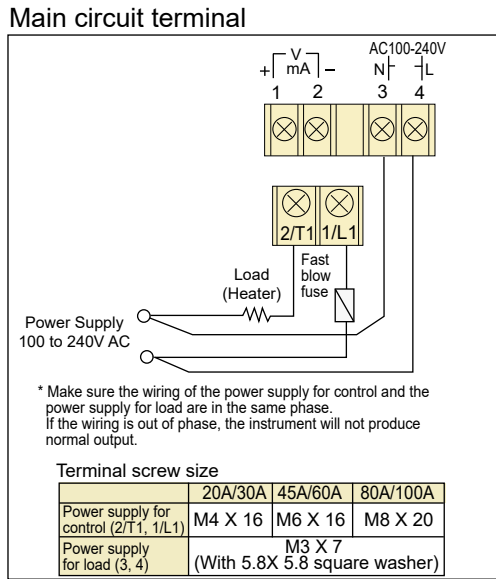
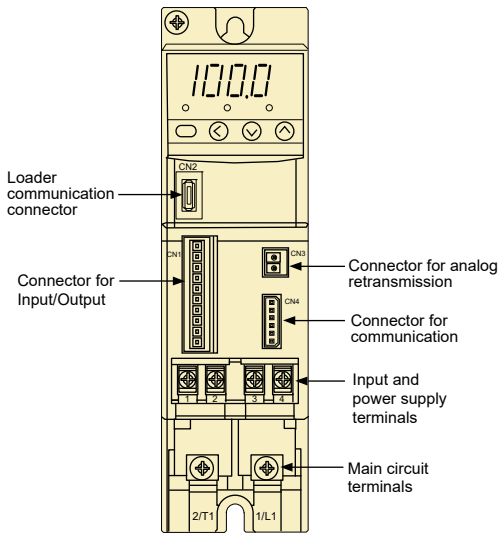

□ Connector

Connector for Input/Output

Pin No.	Contents
1	+5V (Gradient setting input)
2	Gradient setting input (0 to 5V input by gradient setter)
3	0V (Gradient setting input, Manual setting input)
4	Manual setting input (0 to 5.0V input by manual setter)
5	+5V (Manual setting input)
6	External contact input : DI +
7	0V (External contact input) : DI -
8	Unused
9	Transistor output (Alarm output) : DO (+)
10	Transistor output (Alarm output) : DO (-)

Connector for analog retransmission output

Pin No.	Contents
1	Analog retransmission output (+)
2	Analog retransmission output (-)

Connector for communication

Pin No.	Symbol	Signal name	
1	SG	Signal ground	Internal connection
2	SG	Signal ground	
3	T/R (A)	Send/Receive data	Internal connection
4	T/R (A)	Send/Receive data	
5	T/R (B)	Send/Receive data	Internal connection
6	T/R (B)	Send/Receive data	

• Auto setting (With gradient setter)

Connector for Input/Output

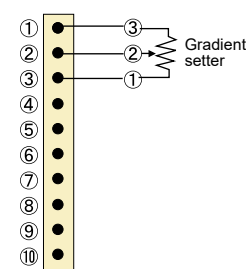

• Auto/Manual setting selection

Connector for Input/Output

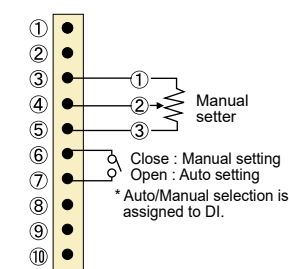

• Auto/Manual setting selection (With gradient setter)

Connector for Input/Output

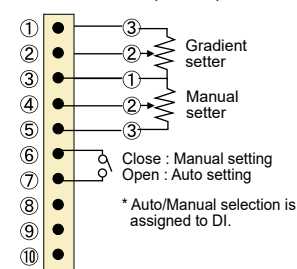

• Manual setting (With manual setter)

Connector for Input/Output

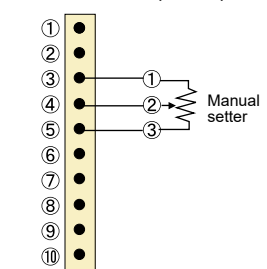

• External contact input

Connector for Input/Output

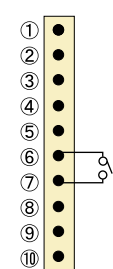

• External contact input can be assigned from function below.

Phase control/Zero-cross control (Continuous proportional)
RUN/STOP
Auto/Manual
External manual/Internal Manual
Heater break alarm : Use/Unuse
Soft-up/Soft/down : Use/Unuse
Setting data lock : Use/Unuse
Over current alarm : Use/Unuse

• Alarm output

Connector for Input/Output

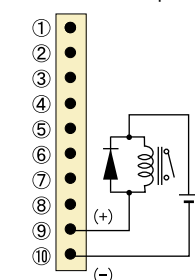

• Alarm output can be assigned from function below.

Heater break alarm 1
Heater break alarm 2
Power frequency abnormal
FAIL (De-energized (Fixed.))
Thyristor break alarm 1
Thyristor break alarm 2
Over current alarm

• Wiring of Output voltmeter

Output voltmeter

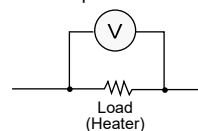

* The output voltmeter is provided with a series resistor

Accessories

• Gradient setter, Manual setter, High/Low setter : THV1P-S01

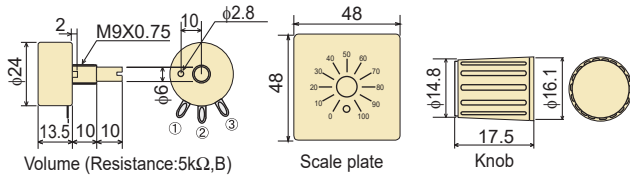

• Output voltmeter : THVP-V01/V02

Can use it only in Phase control.

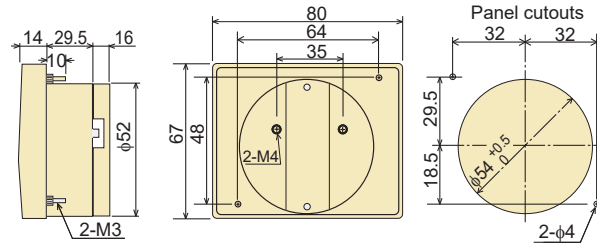

• Fuse Holder

• Fast-blow fuse [1 piece] + Holder [1 circuit type] 20A/30A/45A type

Model Code	Name
THVP-F22	Holder + 20A Fast-blow fuse (1 piece)
THVP-F32	Holder + 30A Fast-blow fuse (1 piece)
THVP-F42	Holder + 45A Fast-blow fuse (1 piece)
THVP-H02	Holder

60A/80A/100A type

Model Code	Name
THVP-F62	Holder + 60A Fast-blow fuse (1 piece)
THVP-FA2	Holder + 80A Fast-blow fuse (1 piece)
THVP-H03	Holder + 100A Fast-blow fuse (1 piece)
THVP-H03	Holder

• Fast-blow fuse [1 piece] + Holder [3 circuit type] 20A/30A type

Model Code	Name
THVP-F21	Holder + 20A Fast-blow fuse (1 piece)
THVP-F31	Holder + 30A Fast-blow fuse (1 piece)
THVP-H01	Holder

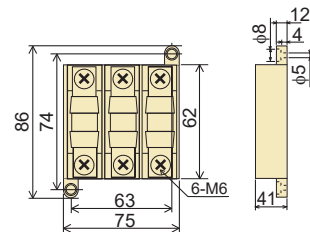
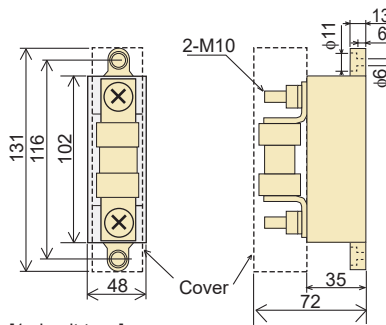
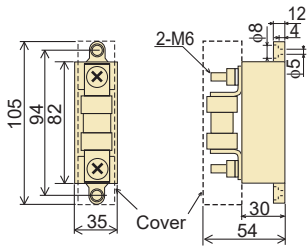

• UL/CE Marking type Fast-blow fuse [1 piece] + Holder [1 circuit type]

• Clamped input terminal type

20A/30A type

Model Code	Name
THVP-F23	Holder + 20A Fast-blow fuse (1 piece)
THVP-F33	Holder + 30A Fast-blow fuse (1 piece)
THVP-H04	Holder

45A/60A/80A/100A type

Model Code	Name
THVP-F43	Holder + 45A Fast-blow fuse (1 piece)
THVP-F63	Holder + 60A Fast-blow fuse (1 piece)
THVP-F83	Holder + 80A Fast-blow fuse (1 piece)
THVP-FA3	Holder + 100A Fast-blow fuse (1 piece)
THVP-H05	Holder

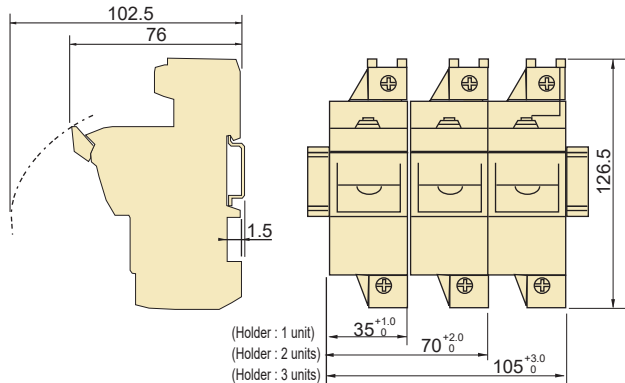
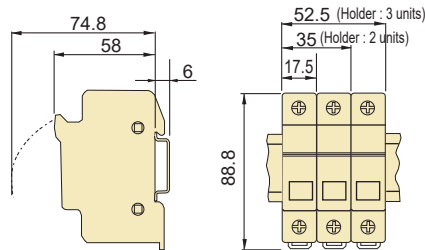

• UL/CE Marking type Fast-blow fuse and Fuse holder
: Manufactured by SIBA GmbH & Co.KG (Germany)



Safety
Warning

- Before operating this product, read the instruction manual carefully to avoid incorrect operation.
- This product is intended for use with industrial machines, test and measuring equipment. It is not designed for use with medical equipment.
- If it is possible that an accident may occur as a result of the failure of the product or some other abnormality, an appropriate independent protection device must be installed.
- When installing this product, avoid the following:
Direct exposure to sunlight. Direct contact with water.
Corrosive environments. Hazardous areas containing explosive or flammable gases.
Vibration or shock.
Areas subject to electrical noise caused by inductive interference, static electricity or magnetic fields.

Caution for imitated products

As products imitating our product now appear on the market, be careful that you don't purchase these imitated products. We will not warrant such products nor bear the responsibility for any damage and/or accident caused by their use.

RKC® **RKC INSTRUMENT INC.**
(RIKA KOGYO CO.,LTD)

HEAD OFFICE : 16-6, KUGAHARA 5 CHOME OHTA-KU TOKYO 146-8515 JAPAN
PHONE : 03-3751-9799 (+81 3 3751 9799)
Email : info@rkcinst.co.jp
FAX : 03-3751-8585 (+81 3 3751 8585)
https://www.rkcinst.com/